

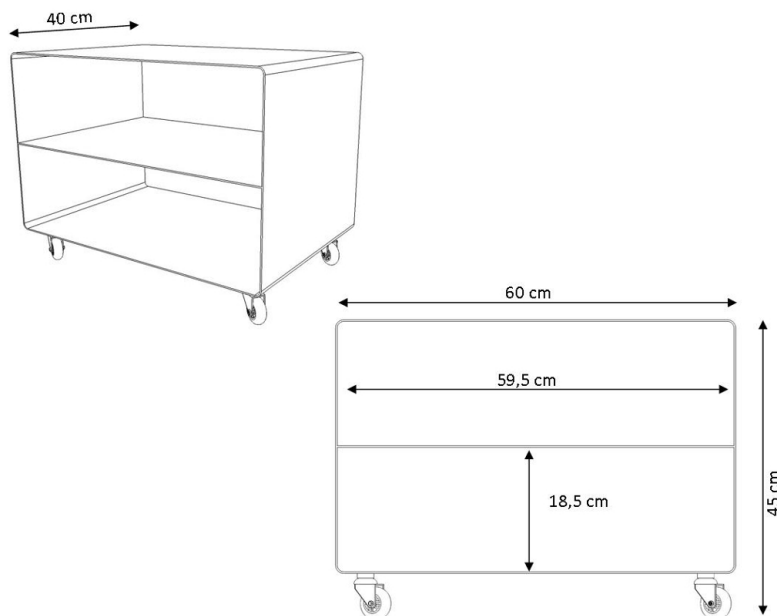











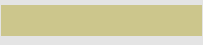
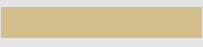
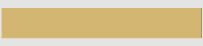







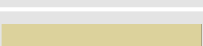
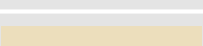
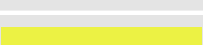

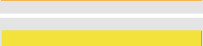
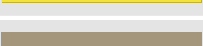
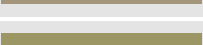

R 103N *Rollwagen und Rollcontainer*





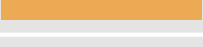







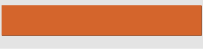

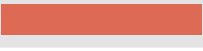







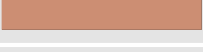
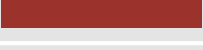

Mobile Line

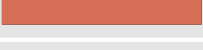

Aufgrund der Metallstärke von 2,5 mm sind die Rollwagen unserer Kollektion Mobile Line so stabil, dass man sie mit bis zu 50 kg belasten kann! Dank äußerst exakter Handwerksarbeit bieten wir die Mobile Line auch mit zwei Wunschfarben in einem Möbel an: Innenlackierung in der einen Farbe, Außenlackierung und Kanten in der anderen. Ein absoluter Wow-Effekt in allen denkbaren RAL-Kombinationen. Industrierollen oder Transparentrollen? Sie haben auch hier die Wahl!







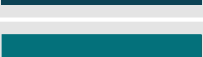

Übersicht aller RAL CLASSIC Farbtöne







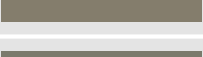



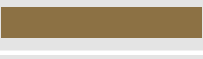







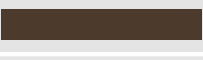





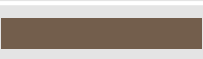
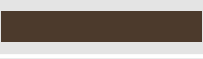
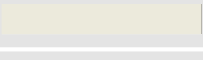

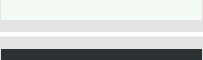
Farbton	Nr	Deutsch	Englisch	Französisch	Spanisch	Italienisch	Niederländisch
	RAL 1000	Grünbeige	Green beige	Beige vert	Beige verdoso	Beige verdastro	Groenbeige
	RAL 1001	Beige	Beige	Beige	Beige	Beige	Beige
	RAL 1002	Sandgelb	Sand yellow	Jaune sable	Amarillo arena	Giallo sabbia	Zandgeel
	RAL 1003	Signalgelb	Signal yellow	Jaune de sécurité	Amarillo señales	Giallo segnale	Signaalgeel
	RAL 1004	Goldgelb	Golden yellow	Jaune or	Amarillo oro	Giallo oro	Goudgeel
	RAL 1005	Honiggelb	Honey yellow	Jaune miel	Amarillo miel	Giallo miele	Honinggeel
	RAL 1006	Maisgelb	Maize yellow	Jaune maïs	Amarillo maiz	Giallo polenta	Maisgeel
	RAL 1007	Narzissengelb	Daffodil yellow	Jaune narcisse	Amarillo narciso	Giallo narciso	Narcissengeel
	RAL 1011	Braunbeige	Brown beige	Beige brun	Beige pardo	Beige marrone	Bruinbeige
	RAL 1012	Zitronengelb	Lemon yellow	Jaune citron	Amarillo limón	Giallo limone	Citroengeel
	RAL 1013	Perlweiß	Oyster white	Blanc perlé	Blanco perla	Bianco perla	Parelwit
	RAL 1014	Elfenbein	Ivory	Ivoire	Marfil	Avorio	Ivoorkleurig
	RAL 1015	Hellelfenbein	Light ivory	Ivoire clair	Marfil claro	Avorio chiaro	Licht ivoorkleurig
	RAL 1016	Schwefelgelb	Sulfur yellow	Jaune soufre	Amarillo azufre	Giallo zolfo	Zwavelgeel
	RAL 1017	Safrangelb	Saffron yellow	Jaune safran	Amarillo azafrán	Giallo zafferano	Saffraangeel
	RAL 1018	Zinkgelb	Zinc yellow	Jaune zinc	Amarillo de zinc	Giallo zinco	Zinkgeel
	RAL 1019	Graubeige	Grey beige	Beige gris	Beige agrisado	Beige grigiastro	Grijsbeige
	RAL 1020	Olivgelb	Olive yellow	Jaune olive	Amarillo oliva	Giallo olivastro	Olijfgeel
	RAL 1021	Rapsgelb	Rape yellow	Jaune colza	Amarillo colza	Giallo navone	Koolzaadgeel
	RAL 1023	Verkehrsgelb	Traffic yellow	Jaune signalisation	Amarillo tráfico	Giallo traffico	Verkeersgeel
	RAL 1024	Ockergelb	Ochre yellow	Jaune ocre	Amarillo ocre	Giallo ocre	Okergeel
	RAL 1027	Currygelb	Curry	Jaune curry	Amarillo curry	Giallo curry	Kerriegeel
	RAL 1028	Meloungelb	Melon yellow	Jaune melon	Amarillo melón	Giallo melone	Meloengeel
	RAL 1032	Ginstergelb	Broom yellow	Jaune genêt	Amarillo retama	Giallo scopa	Bremgeel
	RAL 1033	Dahliengelb	Dahlia yellow	Jaune dahlia	Amarillo dalia	Giallo dahlien	Dahliageel
	RAL 1034	Pastellgelb	Pastel yellow	Jaune pastel	Amarillo pastel	Giallo pastello	Pastelgeel
	RAL 1037	Sonnengelb	Sun yellow	Jaune soleil	Amarillo sol	Giallo sole	Zonnegeel
	RAL 2000	Gelborange	Yellow orange	Orangé jaune	Amarillo naranja	Arancio giallastro	Geeloranje
	RAL 2001	Rotorange	Red orange	Orangé rouge	Rojo anaranjado	Arancio rossastro	Roodoranje
	RAL 2002	Blutorange	Vermilion	Orangé sang	Naranja sanguineo	Arancio sanguigno	Vermiljoen

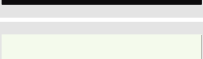
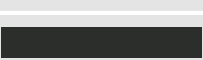
	RAL 2003	Pastellorange	Pastel orange	Orangé pastel	Naranja pálido	Arancio pastello	Pasteloranje
	RAL 2004	Reinorange	Pure orange	Orangé pur	Naranja puro	Arancio puro	Zuiver oranje
	RAL 2008	Hellrotorange	Bright red orange	Orangé rouge clair	Rojo claro anaranjado	Rosso arancio chiaro	Licht roodoranje
	RAL 2009	Verkehrsorange	Traffic orange	Orangé signalisation	Naranja tráfico	Arancio traffico	Verkeersoranje
	RAL 2010	Signalorange	Signal orange	Orangé de sécurité	Naranja señales	Arancio segnale	Signaaloranje
	RAL 2011	Tieforange	Deep orange	Orangé foncé	Naranja intenso	Arancio profondo	Dieporanje
	RAL 2012	Lachsorange	Salmon orange	Orangé saumon	Naranja salmón	Arancio salmone	Zalmoranje
	RAL 3000	Feuerrot	Flame red	Rouge feu	Rojo vivo	Rosso fuoco	Vuurrood
	RAL 3001	Signalrot	Signal red	Rouge de sécurité	Rojo señales	Rosso segnale	Signaalrood
	RAL 3002	Karminrot	Carmine red	Rouge carmin	Rojo carmin	Rosso carminio	Karmijnrood
	RAL 3003	Rubinrot	Ruby red	Rouge rubis	Rojo rubí	Rosso rubino	Robijnrood
	RAL 3004	Purpurrot	Purple red	Rouge pourpre	Rojo purpura	Rosso porpora	Purperrood
	RAL 3005	Weinrot	Wine red	Rouge vin	Rojo vino	Rosso vino	Wijnrood
	RAL 3007	Schwarzrot	Black red	Rouge noir	Rojo negruzco	Rosso nerastro	Zwartrood
	RAL 3009	Oxidrot	Oxide red	Rouge oxyde	Rojo óxido	Rosso ossido	Oxyderoed
	RAL 3011	Braunrot	Brown red	Rouge brun	Rojo pardo	Rosso marrone	Bruinrood
	RAL 3012	Beigerot	Beige red	Rouge beige	Rojo beige	Rosso beige	Beigerood
	RAL 3013	Tomatenrot	Tomato red	Rouge tomate	Rojo tomate	Rosso pomodoro	Tomaatrood
	RAL 3014	Altrosa	Antique pink	Vieux rose	Rojo viejo	Rosa antico	Oudroze
	RAL 3015	Hellrosa	Light pink	Rose clair	Rosa claro	Rosa chiaro	Lichtroze
	RAL 3016	Korallenrot	Coral red	Rouge corail	Rojo coral	Rosso corallo	Koraalrood
	RAL 3017	Rosé	Rose	Rosé	Rosa	Rosato	Bleekrood
	RAL 3018	Erdbeerrot	Strawberry red	Rouge fraise	Rojo fresa	Rosso fragola	Aardbeiroot
	RAL 3020	Verkehrsrot	Traffic red	Rouge signalisation	Rojo tráfico	Rosso traffico	Verkeersrood
	RAL 3022	Lachsrot	Salmon pink	Rouge saumon	Rojo salmón	Rosso salmone	Zalmrood
	RAL 3027	Himbeerrot	Raspberry red	Rouge framboise	Rojo frambuesa	Rosso lampone	Framboosrood
	RAL 3031	Orientrot	Orient red	Rouge oriental	Rojo oriente	Rosso oriente	Oriëntrood
	RAL 4001	Rotlila	Red lilac	Lilas rouge	Rojo lila	Lilla rossastro	Roodlila
	RAL 4002	Rotviolett	Red violet	Violet rouge	Rojo violeta	Viola rossastro	Roodpaars
	RAL 4003	Erikaviolett	Heather violet	Violet bruyère	Violeta érica	Viola erica	Heidepaars
	RAL 4004	Bordeauxviolett	Claret violet	Violet bordeaux	Burdeos	Viola bordeaux	Bordeauxpaars
	RAL 4005	Blaulila	Blue lilac	Lilas bleu	Lila azulado	Lilla blauastro	Blauwlila

	RAL 4006	Verkehrspurpur	Traffic purple	Pourpre signalisation	Púrpurá tráfico	Porpora traffico	Verkeerspurper
	RAL 4007	Purpurviolett	Purple violet	Violet pourpre	Violeta púrpura	Porpora violetto	Purperviolet
	RAL 4008	Signalviolett	Signal violet	Violet de sécurité	Violeta señales	Violetto segnale	Signaalviolet
	RAL 4009	Pastellviolett	Pastel violet	Violet pastel	Violeta pastel	Violetto pastello	Pastelviolet
	RAL 4010	Telemagenta	Telemagenta	Telemagenta	Magenta tele	Tele Magenta	Telemagenta
	RAL 5000	Violettblau	Violet blue	Bleu violet	Azul violeta	Blu violaceo	Paarsblauw
	RAL 5001	Grünblau	Green blue	Bleu vert	Azul verdoso	Blu verdastro	Groenblauw
	RAL 5002	Ultramarinblau	Ultramarine blue	Bleu outremer	Azul ultramar	Blu oltremare	Ultramarijnblauw
	RAL 5003	Saphirblau	Sapphire blue	Bleu saphir	Azul zafiro	Blu zaffiro	Saffierblauw
	RAL 5004	Schwarzblau	Black blue	Bleu noir	Azul negruzco	Blu nerastro	Zwartblauw
	RAL 5005	Signalblau	Signal blue	Bleu de sécurité	Azul señales	Blu segnale	Signaalblauw
	RAL 5007	Brillantblau	Brillant blue	Bleu brillant	Azul brillante	Blu brillante	Brijlantblauw
	RAL 5008	Graublau	Grey blue	Bleu gris	Azul grisáceo	Blu grigiastro	Grijsblauw
	RAL 5009	Azurblau	Azure blue	Bleu azur	Azul azur	Blu azzurro	Azuurblauw
	RAL 5010	Enzianblau	Gentian blue	Bleu gentiane	Azul genciana	Blu genziana	Gentiaanblauw
	RAL 5011	Stahlblau	Steel blue	Bleu acier	Azul acero	Blu acciaio	Staalblauw
	RAL 5012	Lichtblau	Light blue	Bleu clair	Azul luminoso	Blu luce	Lichtblauw
	RAL 5013	Kobaltblau	Cobalt blue	Bleu cobalt	Azul cobalto	Blu cobalto	Kobaltblauw
	RAL 5014	Taubenblau	Pigeon blue	Bleu pigeon	Azul colombino	Blu colomba	Duifblauw
	RAL 5015	Himmelblau	Sky blue	Bleu ciel	Azul celeste	Blu cielo	Hemelsblauw
	RAL 5017	Verkehrsblau	Traffic blue	Bleu signalisation	Azul tráfico	Blu traffico	Verkeersblauw
	RAL 5018	Türkisblau	Turquoise blue	Bleu turquoise	Azul turquesa	Blu turchese	Turkooisblauw
	RAL 5019	Capriblau	Capri blue	Bleu capri	Azul capri	Blu Capri	Capriblauw
	RAL 5020	Ozeanblau	Ocean blue	Bleu océan	Azul oceano	Blu oceano	Oceaanblauw
	RAL 5021	Wasserblau	Water blue	Bleu d'eau	Azul agua	Blu acqua	Waterblauw
	RAL 5022	Nachtblau	Night blue	Bleu nocturne	Azul noche	Blu notte	Nachtblauw
	RAL 5023	Fernblau	Distant blue	Bleu distant	Azul lejania	Blu distante	Verblauw
	RAL 5024	Pastellblau	Pastel blue	Bleu pastel	Azul pastel	Blu pastello	Pastelblauw
	RAL 6000	Patinagrün	Patina green	Vert patine	Verde patina	Verde patina	Patinagroen
	RAL 6001	Smaragdgrün	Emerald green	Vert émeraude	Verde esmeralda	Verde smeraldo	Smaragdgroen
	RAL 6002	Laubgrün	Leaf green	Vert feuillage	Verde hoja	Verde foglia	Loofgroen
	RAL 6003	Olivgrün	Olive green	Vert olive	Verde oliva	Verde oliva	Olijfgroen

	RAL 6004	Blaugrün	Blue green	Vert bleu	Verde azulado	Verde bluastro	Blauwgroen
	RAL 6005	Moosgrün	Moss green	Vert mousse	Verde musgo	Verde muschio	Mosgroen
	RAL 6006	Grauliv	Grey olive	Olive gris	Oliva grisáceo	Oliva grigiastro	Grijs olijfgroen
	RAL 6007	Flaschengrün	Bottle green	Vert bouteille	Verde botella	Verde bottiglia	Flessegroen
	RAL 6008	Braungrün	Brown green	Vert brun	Verde parduzco	Verde brunastro	Bruingroen
	RAL 6009	Tannengrün	Fir green	Vert sapin	Verde abeto	Verde abete	Dennegroen
	RAL 6010	Grasgrün	Grass green	Vert herbe	Verde hierba	Verde erba	Grasgroen
	RAL 6011	Resedagrün	Reseda green	Vert réséda	Verde reseda	Verde reseda	Resedagroen
	RAL 6012	Schwarzgrün	Black green	Vert noir	Verde negruzco	Verde nerastro	Zwartgroen
	RAL 6013	Schilfgrün	Reed green	Vert jonc	Verde caña	Verde canna	Rietgroen
	RAL 6014	Gelboliv	Yellow olive	Olive jaune	Amarillo oliva	Oliva giallastro	Geel olijfgroen
	RAL 6015	Schwarzoliv	Black olive	Olive noir	Oliva negruzco	Oliva nerastro	Zwart olijfgroen
	RAL 6016	Türkisgrün	Turquoise green	Vert turquoise	Verde turquesa	Verde turchese	Turkooisgroen
	RAL 6017	Maigrün	May green	Vert mai	Verde mayo	Verde maggio	Meigroen
	RAL 6018	Gelbgrün	Yellow green	Vert jaune	Verde amarillento	Verde giallastro	Geelgroen
	RAL 6019	Weißgrün	Pastel green	Vert blanc	Verde blanquecino	Verde biancastro	Witgroen
	RAL 6020	Chromoxidgrün	Chrome green	Vert oxyde chromique	Verde cromo	Verde cromo	Chroomoxydegroen
	RAL 6021	Blassgrün	Pale green	Vert pâle	Verde pálido	Verde pallido	Bleekgroen
	RAL 6022	Braunoliv	Olive drab	Olive brun	Oliva parduzco	Oliva brunastro	Bruin olijfgroen
	RAL 6024	Verkehrsgrün	Traffic green	Vert signalisation	Verde tráfico	Verde traffico	Verkeersgroen
	RAL 6025	Farngrün	Fern green	Vert fougère	Verde helecho	Verde felce	Varengroen
	RAL 6026	Opalgrün	Opal green	Vert opale	Verde opalo	Verde opale	Opaalgroen
	RAL 6027	Lichtgrün	Light green	Vert clair	Verde luminoso	Verde chiaro	Lichtgroen
	RAL 6028	Kieferngrün	Pine green	Vert pin	Verde pino	Verde pino	Pijnboomgroen
	RAL 6029	Minzgrün	Mint green	Vert menthe	Verde menta	Verde menta	Mintgroen
	RAL 6032	Signalgrün	Signal green	Vert de sécurité	Verde señales	Verde segnale	Signaalgroen
	RAL 6033	Minttürkis	Mint turquoise	Turquoise menthe	Turquesa menta	Turchese menta	Mintturquoise
	RAL 6034	Pastelltürkis	Pastel turquoise	Turquoise pastel	Turquesa pastel	Turchese pastello	Pastelturquoise
	RAL 7000	Fehgrau	Squirrel grey	Gris petit-gris	Gris ardilla	Grigio vaio	Pelsgrijs
	RAL 7001	Silbergrau	Silver grey	Gris argent	Gris plata	Grigio argento	Zilvergrijs
	RAL 7002	Olivgrau	Olive grey	Gris olive	Gris oliva	Grigio olivastro	Olijfgrijs
	RAL 7003	Moosgrau	Moss grey	Gris mousse	Gris musgo	Grigio muschio	Mosgrijs

	RAL 7004	Signalgrau	Signal grey	Gris de sécurité	Gris señales	Grigio segnale	Signaalgrijs
	RAL 7005	Mausgrau	Mouse grey	Gris souris	Gris ratón	Grigio topo	Muisgrijs
	RAL 7006	Beigegräu	Beige grey	Gris beige	Gris beige	Grigio beige	Beigegrijs
	RAL 7008	Khakigräu	Khaki grey	Gris kaki	Gris caqui	Grigio kaki	Kakigrijs
	RAL 7009	Grüngräu	Green grey	Gris vert	Gris verdoso	Grigio verdastro	Groengrijs
	RAL 7010	Zeltgräu	Tarpaulin grey	Gris tente	Gris lona	Grigio tenda	Zeildoekgrijs
	RAL 7011	Eisengräu	Iron grey	Gris fer	Gris hierro	Grigio ferro	Ijzergrijs
	RAL 7012	Basaltgräu	Basalt grey	Gris basalte	Gris basalto	Grigio basalto	Bazaltgrijs
	RAL 7013	Braungräu	Brown grey	Gris brun	Gris parduzco	Grigio brunastro	Bruingrijs
	RAL 7015	Schiefergräu	Slate grey	Gris ardoise	Gris pizarra	Grigio ardesia	Leigrijs
	RAL 7016	Anthrazitgräu	Anthracite grey	Gris anthracite	Gris antracita	Grigio antracite	Antracietgrijs
	RAL 7021	Schwarzgräu	Black grey	Gris noir	Gris negruzco	Grigio nerastro	Zwartgrijs
	RAL 7022	Umbragräu	Umbra grey	Gris terre d'ombre	Gris sombra	Grigio ombra	Ombergrijs
	RAL 7023	Betongräu	Concrete grey	Gris béton	Gris hormigón	Grigio calcestruzzo	Betongrijs
	RAL 7024	Graphitgräu	Graphite grey	Gris graphite	Gris grafita	Grigio grafite	Grafietgrijs
	RAL 7026	Granitgräu	Granite grey	Gris granit	Gris granito	Grigio granito	Grانيتgrijs
	RAL 7030	Steingräu	Stone grey	Gris pierre	Gris piedra	Grigio pietra	Steengrijs
	RAL 7031	Blaugräu	Blue grey	Gris bleu	Gris azulado	Grigio bluastro	Blauwgrijs
	RAL 7032	Kieselgräu	Pebble grey	Gris silex	Gris guijarro	Grigio ghiaia	Kiezelgrijs
	RAL 7033	Zementgräu	Cement grey	Gris ciment	Gris cemento	Grigio cemento	Cementgrijs
	RAL 7034	Gelbgräu	Yellow grey	Gris jaune	Gris amarillento	Grigio giallastro	Geelgrijs
	RAL 7035	Lichtgräu	Light grey	Gris clair	Gris luminoso	Grigio luce	Lichtgrijs
	RAL 7036	Platingräu	Platinum grey	Gris platine	Gris platino	Grigio platino	Platinagrijs
	RAL 7037	Staubgräu	Dusty grey	Gris poussière	Gris polvo	Grigio polvere	Stofgrijs
	RAL 7038	Achatgräu	Agate grey	Gris agate	Gris ágata	Grigio agata	Agaatgrijs
	RAL 7039	Quarzgräu	Quartz grey	Gris quartz	Gris cuarzo	Grigio quarzo	Kwartsgrijs
	RAL 7040	Fenstergräu	Window grey	Gris fenêtre	Gris ventana	Grigio finestra	Venstergrijs
	RAL 7042	Verkehrsgräu A	Traffic grey A	Gris signalisation A	Gris tráfico A	Grigio traffico A	Verkeersgrijs A
	RAL 7043	Verkehrsgräu B	Traffic grey B	Gris signalisation B	Gris tráfico B	Grigio traffico B	Verkeersgrijs B
	RAL 7044	Seidengräu	Silk grey	Gris soie	Gris seda	Grigio seta	Zijdegrijs
	RAL 7045	Telegräu 1	Telegrey 1	Telegris 1	Gris tele 1	Tele grigio 1	Telegrijs 1
	RAL 7046	Telegräu 2	Telegrey 2	Telegris 2	Gris tele 2	Tele grigio 2	Telegrijs 2

	RAL 7047	Telegrau 4	Telegrey 4	Telegris 4	Gris tele 4	Tele grigio 4	Telegrijs 4
	RAL 8000	Grünbraun	Green brown	Brun vert	Pardo verdoso	Marrone verdastro	Groenbruin
	RAL 8001	Ockerbraun	Ochre brown	Brun terre de Sienne	Pardo ocre	Marrone ocre	Okerbruin
	RAL 8002	Signalbraun	Signal brown	Brun de sécurité	Marrón señales	Marrone segnale	Signaalbruin
	RAL 8003	Lehmbraun	Clay brown	Brun argile	Pardo arcilla	Marrone fango	Leembruin
	RAL 8004	Kupferbraun	Copper brown	Brun cuivré	Pardo cobre	Marrone rame	Koperbruin
	RAL 8007	Rehbraun	Fawn brown	Brun fauve	Pardo corzo	Marrone capriolo	Reebruin
	RAL 8008	Olivbraun	Olive brown	Brun olive	Pardo oliva	Marrone oliva	Olijfbruin
	RAL 8011	Nussbraun	Nut brown	Brun noisette	Pardo nuez	Marrone noce	Notebruin
	RAL 8012	Rotbraun	Red brown	Brun rouge	Pardo rojo	Marrone rossiccio	Roodbruin
	RAL 8014	Sepiabraun	Sepia brown	Brun sépia	Sepia	Marrone seppia	Sepiabuin
	RAL 8015	Kastanienbraun	Chestnut brown	Marron	Castaña	Marrone castagna	Kastanjebruin
	RAL 8016	Mahagonibraun	Mahogany brown	Brun acajou	Caoba	Marrone mogano	Mahoniebruin
	RAL 8017	Schokoladenbraun	Chocolate brown	Brun chocolat	Chocolate	Marrone cioccolata	Chocoladebruin
	RAL 8019	Graubraun	Grey brown	Brun gris	Pardo grisáceo	Marrone grigiastro	Grijsbruin
	RAL 8022	Schwarzbraun	Black brown	Brun noir	Pardo negruzco	Marrone nerastro	Zwartbruin
	RAL 8023	Orangebraun	Orange brown	Brun orangé	Pardo anaranjado	Marrone arancio	Oranjebruin
	RAL 8024	Beigebraun	Beige brown	Brun beige	Pardo beige	Marrone beige	Beigebuin
	RAL 8025	Blassbraun	Pale brown	Brun pâle	Pardo pálido	Marrone pallido	Bleekbruin
	RAL 8028	Terrabraun	Terra brown	Brun terre	Marrón tierra	Marrone terra	Terrabuin
	RAL 9001	Cremeweiß	Cream	Blanc crème	Blanco crema	Bianco crema	Crèmewit
	RAL 9002	Grauweiß	Grey white	Blanc gris	Blanco grisáceo	Bianco grigiastro	Grijswit
	RAL 9003	Signalweiß	Signal white	Blanc de sécurité	Blanco señales	Bianco segnale	Signaalwit
	RAL 9004	Signalschwarz	Signal black	Noir de sécurité	Negro señales	Nero segnale	Signaalzwart
	RAL 9005	Tiefschwarz	Jet black	Noir foncé	Negro intenso	Nero intenso	Gitzwart
	RAL 9010	Reinweiß	Pure white	Blanc pur	Blanco puro	Bianco puro	Zuiver wit
	RAL 9011	Graphitschwarz	Graphite black	Noir graphite	Negro grafito	Nero grafite	Grafietzwart
	RAL 9016	Verkehrsweiß	Traffic white	Blanc signalisation	Blanco tráfico	Bianco traffico	Verkeerswit
	RAL 9017	Verkehrsschwarz	Traffic black	Noir signalisation	Negro tráfico	Nero traffico	Verkeerszwart
	RAL 9018	Papyrusweiß	Papyrus white	Blanc papyrus	Blanco papiro	Bianco papiro	Papyruswit
	RAL 9006	Weißaluminium	White aluminium	Aluminium blanc	Aluminio blanco	Aluminio brillante	Blank aluminiumkleurig
	RAL 9007	Graualuminium	Grey aluminium	Aluminium gris	Aluminio gris	Aluminio grigiastro	Grijs aluminiumkleurig

	RAL 1035	Perlbeige	Pearl beige	Beige nacré	Beige perlado	Beige perlato	Parelmoergrijs
	RAL 1036	Perlgold	Pearl gold	Or nacré	Oro perlado	Oro perlato	Parelmoergoud
	RAL 2013	Perlorange	Pearl orange	Orangé nacré	Naranja perlado	Arancio perlato	Parelmoeroranje
	RAL 3032	Perl Rubinrot	Pearl ruby red	Rouge rubis nacré	Rojo rubí perlado	Rosso rubino perlato	Parelmoerdonkerrood
	RAL 3033	Perlrosa	Pearl pink	Rose nacré	Rosa perlado	Rosa perlato	Parelmoerlichtrood
	RAL 4011	Perlviolett	Pearl violet	Violet nacré	Violeta perlado	Violetto perlato	Parelmoerdonkerviolet
	RAL 4012	Perlbrombeer	Pearl blackberry	Mûre nacré	Morado perlado	Mora perlato	Parelmoerlichtviolet
	RAL 5025	Perlenzian	Pearl gentian blue	Gentiane nacré	Gencian perlado	Blu genziana perlato	Parelmoerblauw
	RAL 5026	Perlnachtblau	Pearl night blue	Bleu nuit nacré	Azul noche perlado	Blu notte perlato	Parelmoernachtblauw
	RAL 6035	Perlgrün	Pearl green	Vert nacré	Verde perlado	Verde perlato	Parelmoerdonkergroen
	RAL 6036	Perlopalgrün	Pearl opal green	Vert opal nacré	Verde ópalo perlado	Verde opalo perlato	Parelmoerlichtgroen
	RAL 7048	Perlmausgrau	Pearl mouse grey	Gris souris nacré	Gris musgo perlado	Grigio topo perlato	Parelmoermuisgrijs
	RAL 8029	Perlkupfer	Pearl copper	Cuivre nacré	Cobre perlado	Rame perlato	Parelmoerkoper
	RAL 9022	Perlhellgrau	Pearl light grey	Gris clair nacré	Gris claro perlado	Grigio chiaro perlato	Parelmoerlichtgrijs
	RAL 9023	Perldunkelgrau	Pearl dark grey	Gris foncé nacré	Gris oscuro perlado	Grigio scuro perlato	Parelmoerdonkergrijs

Bitte beachten Sie, dass die Farben je nach verwendetem Monitor variieren können!

Sämtliche Perl- und Metallicfarben können aufgrund ihres Glanzanteils nicht korrekt dargestellt werden.

Perlfarben:

RAL 1035, RAL 1036, RAL 2013, RAL 3032, RAL 3033, RAL 4011, RAL 4012, RAL 5025, RAL 5026, RAL 6035, RAL 6036, RAL 7048, RAL 8029, RAL 9022, RAL 9023

Metallicfarben:

RAL 9006, RAL 9007